

PHILIPS RT30A & RT960A High Density Video Cassette Recorder

Instructions for Use



en

fr

de

es

nl

it

pt

IMPORTANT SAFEGUARDS



The lightning flash with an arrowhead symbol, within an equilateral triangle, is intended to alert the user to the presence of uninsulated "dangerous voltage" within the product's enclosure that may be of sufficient magnitude to constitute a risk of electric shock to persons.



The exclamation point within an equilateral triangle is intended to alert the user to presence of important operating and maintenance (servicing) instructions in the literature accompanying the appliance.

1. Read these instructions.
2. Keep these instructions.
3. Comply with all warnings.
4. Follow all instructions.
5. Do not use this equipment near water.
6. Clean only with dry cloth.
7. Do not block any ventilation openings. Install in accordance with the manufacturer's instructions.
8. Do not install near any heat sources such as radiators, heat registers, stoves, or other equipment (including amplifiers) that produce heat.
9. Do not defeat the safety purpose of the polarized or grounding-type plug. A polarized plug has two blades with one wider than the other. A grounding type plug has two blades and a third grounding prong. Both the wide blade and the third prong are provided for your safety. If the provided plug does not fit into your outlet, consult an electrician for replacement of the obsolete outlet.
10. Protect the power cord from being walked on or pinched particularly at plugs, convenience receptacles, and the point where they exit from the equipment.
11. Only use attachments/accessories specified by the manufacturer.
12. Unplug this equipment during lightning storms or when unused for long periods of time.
13. Refer all servicing to qualified service personnel. Servicing is required when the equipment has been damaged in any way, such as power-supply cord or plug is damaged, liquid has been spilled or objects have fallen into the equipment, the equipment has been exposed to rain or moisture, does not operate normally, or has been dropped.
14. **WARNING:** To reduce the risk of fire or electric shock, do not expose this equipment to rain or moisture.



15. The equipment shall not be exposed to dripping or splashing and that no objects filled with liquids, such as vases, shall be placed on the equipment.
16. The back of the recorder should only be removed by qualified maintenance and service personnel.

VENTILATION

17. Keep ventilation openings free to avoid the recorder for overheating.
18. Do not place the recorder in the immediate vicinity of a heating source.
19. Do not install this equipment in a confined space such as a bookcase or similar unit.

CLEANING

20. You can clean the recorder with a moist fluff-free cloth or shammy leather cloth.

DISPOSAL

21. This recorder contains a battery. Do not dispose of the battery with other solid waste. The battery is located inside the recorder. To remove the battery, remove the recorder cover by unscrewing the 4 crosshead screws, remove the cover, then break off the battery from the circuit board.

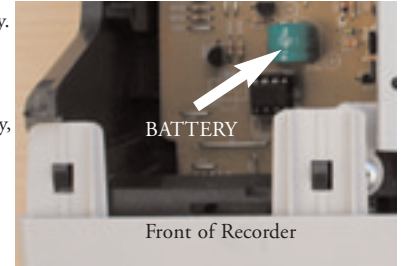

CAUTION: Danger of explosion if batteries are incorrectly replaced. Replace only with the same or equivalent type.

Remark: Philips has a strong commitment towards the environment. This recorder has been designed to respect the environment as much as possible.

FCC Information

This equipment has been tested and found to comply with the limits for a Class B digital device, pursuant to part 15 of the FCC Rules. These limits are designed to provide reasonable protection against harmful interference in a residential installation. This equipment generates, uses and can radiate radio frequency energy and, if not installed and used in accordance with the instructions, may cause harmful interference to radio communications. However, there is no guarantee that interference will not occur in a particular installation. If this equipment does cause harmful interference to radio or television reception, which can be determined by turning the equipment off and on, the user is encouraged to try to correct the interference by one or more of the following measures:

- Reorient or relocate the receiving antenna.
- Increase the separation between the equipment and receiver.
- Connect the equipment into an outlet on a circuit different from that to which the receiver is connected.
- Consult the dealer or an experienced radio/ TV technician for help.

Note: Any change or modification not expressly approved by Philips of the equipment authorization could void the user's authority to operate the equipment.

For additional information or to speak to a representative, please contact the Philips Communication, Security & Imaging location nearest you or visit our web site at www.Philipscsi.com.

(See: *Your Guide To Observation*)



WARNING: This device is intended for use in public areas only. Surreptitious recording of oral communications is strictly prohibited by U.S. Federal law

CONTENTS

1	UNPACKING	I-3
2	SERVICE	I-3
3	DESCRIPTION	I-3
4	CONTROLS	I-4
4.1	Controls and Functions	I-4
5	INSTALLATION	I-7
5.1	Video Connection (Fig 4, Item 3)	I-7
5.2	Audio Connection (Fig 4, Item 2)	I-7
5.3	Using the 12-pin Terminals (Fig 4, Item 4)	I-7
5.4	VCR Setup	I-8
5.5	Video Cassette Tapes	I-10
5.6	Normal Playback	I-10
5.7	Normal Recording	I-12
6	Setting the On-Screen Display	I-13
6.1	CLOCK SET UP Menu	I-14
6.2	RECORD MODE SET UP Menu	I-14
6.3	TIMER RECORD SET UP Menu	I-16
6.4	REVIEW MODE Menu	I-16
6.5	SYSTEM SET UP Menu	I-17
6.6	SEARCH SET UP Menu	I-18
7.	SELF-DIAGNOSIS	I-19
8.	TROUBLESHOOTING	I-20
9.	MAINTENANCE GUIDE TABLE	I-21
10.	SPECIFICATIONS	I-22

1 UNPACKING

Unpack carefully. This is electronic equipment and should be handled carefully. Check to ensure that the following items are included:

- Model number of VCR.
- This Instruction for Use.

If an item appears to have been damaged in shipment, replace it properly in its carton and notify the shipping agent. If any items are missing, notify your Philips Communication, Security & Imaging Sales Representative or Customer Service. The shipping carton is the safest container in which the unit may be transported. Save it for possible future use.

2 SERVICE

If the unit ever needs repair service, the customer should contact their Dealer or Service Center for return authorization and shipping instructions.

3 DESCRIPTION

When you use a VCR as backup to your observation and monitoring practices, you no longer have to worry about missing a thing. With the RT30A and RT960A Series 30hr and 960hr High Density Video Cassette Recorders you have superior video and audio quality with the versatility to best suit your application needs.

The high density RT30A and RT960A feature gives you double (PAL) / triple (NTSC) the number of picture updates per second than conventional VCRs, ensuring you do not miss any incident, yet keeping the high quality picture. Highly developed compact mechanical components ensure long lasting reliability even with the high speed rewind of less than 70 sec.

The RT30A gives the option of recording events with 6, 18 or 30 hrs of real-time video. The RT960A provides the same real-time video plus up to 960 hrs of time-lapse video. Audio recording and playback is also available in the 6, 18 and 30 hour modes.

Fantastic features like the superimposed on-screen menu in 7 languages provide easy setup. Other features include built-in time/date generator, a built-in back-up battery that provides time/date/settings backup during power loss for up to 2 weeks, joggle shuttle for instant picture retrieval, tape remaining indication and automatic recording after power failure. The list is endless, ensuring that these VCRs can meet your required application specification.

Technically the RT30A and RT960A are the most advanced Real-Time video recorders available. V-Sync selection, "video-through", security-lock, video-loss, Vext-pulse and V-Lock functions are just a few features that will enhance the functions that need special attention.

Alarm detection is operational from the recording or ready modes and will turn on the alarm indicator and "Alarm-On" output. It also inserts an Alarm-Code in the on-screen display for easy location during later alarm search. The selected alarm recording speed can be programmed to continue for a period of 30 seconds, 1, 3, 5, 10 minutes or until tape end.

Whatever your needs are for recording and monitoring, the RT30A and RT960A will provide you with a trouble free, easy-to-use advanced real-time video recording for your specific application area.

Features include:

Recording:

- Double (PAL)/Triple (NTSC) Density Video Cassette Recorder.
- RT30A has three Selectable Recording Speeds (6, 18, 30 hours). RT960A has ten Selectable Recording Speeds (6, 18, 30, 72, 96, 120, 168, 240, 480, 960 hours).
- High speed rewind (less than 70 sec. [E180/T120 tape]).
- Alarm recording with selectable duration and selectable recording speed.
- Recording Check.
- On-Screen and On-Tape Time/Date Information.
- 8 programmable 7-day program timer settings.
- Tape remain Information.
- Automatic repeat recording.
- Automatic recording restart after power loss has been restored.
- Series recording (when using two or more VCRs).
- "Alarm On" Output.
- Audio at 6, 18 and 30 hour speeds.

Playback:

- Time-of-Alarm Memory and Alarm Index Search.
- High Speed Visual Search.
- RT30A has three Playback Speeds (6, 18, 30 hours), RT960A has ten Playback Speeds (6, 18, 30, 72, 96, 120, 168, 240, 480, 960 hours).
- Still Field, Field-Advance, and Field-Reverse.

Security:

- Built-in rechargeable back-up battery (2 weeks).
- Electronic Security Lockout.

4 CONTROLS

Note: This recorder has a battery to maintain display functions and recording mode within 2 weeks in the event of power loss. When the recorder is received, the unit must be connected to power source for 48 hours to assure the battery has been adequately charged.

Safety



Should any solid object or liquid fall into the cabinet, turn off the unit and have it checked by qualified personnel before operating it any further.



To disconnect the power cord, pull it out by the plug. Never pull the cord itself.

Installation Requirements:

- Choose a location in which air can pass through the ventilation holes in the bottom, top and back of the unit to prevent it from overheating.
- Do not install the unit near sources such as radiators or air ducts or in a place subject to direct sunlight, excessive dust, mechanical vibrations or shock.
- Never bring a magnet or magnetized object near the VCR because it will adversely affect the performance of the VCR.
- Do not install the unit in an inclined position. The unit is designed for operation in a horizontal position.

Operation:

- Condensation: If you pour a cold liquid into a glass, water vapor in the air will condense on the surface of glass. This is the condensation of moisture. Condensation on the head drum, one of the most crucial parts of the VCR, will cause damage to the tape. The VCR should not be operated for at least 2 hours after being moved from a cold to a hot environment to avoid condensation from occurring on the head drum.

Cleaning:

- Be careful: When surface of the case is wiped with a volatile agent such as benzine, alcohol, thinner, etc., or a chemically processed cloth, the surface finish may be degraded or its coating may peel off.

Repacking:

- It is wise to save the packing materials and box in case you ever need to ship or store your unit.

4.1 Controls and Functions

Operational Controls:

- POWER button** - Press for on; press again for off. The display window becomes brighter when the VCR is switched on. When you select power off, the timer program is operational if the option has been setup.
- REC (RECORD) button** - Press to begin recording.
- Cassette loading slot** - Cassette tape is inserted in this slot.
- Shuttle Ring** - The shuttle ring is the outer dial. When the VCR is in STOP mode, the shuttle ring can be rotated to the left or right then released, and the VCR will engage in the REWIND or FAST FORWARD function. While in the REWIND or FAST FORWARD mode, the shuttle ring can be rotated and held to engage the LOGIC search mode. Releasing the shuttle ring returns it to the REWIND or FAST FORWARD function. Refer to paragraph 5.6.1 for detailed operation.
- Jog Ring** - The jog ring is the center dial of the jog-shuttle ring. This ring is used to advance or reverse the video by single field when in the still mode. Refer to paragraph 5.6.1 for detailed operation.
- PLAY button** - Press to play back a previously recorded tape. Pressing this button while recording provides confirmation of the recording operation. The tape plays back the last 4 seconds of video then returns to the recording mode.
- STOP button** - Press once to discontinue all tape related functions. Press a second time to eject the cassette.
- STILL button** - When pressed during recording, tape movement stops temporarily. Press again to continue the recording. When pressed during playback, tape movement stops. Press again to advance by still frame. Press the PLAY button to continue playback.
- CLEAR button** - Press to delete the information stored on the screen display, such as Alarm review, Power fail and Timer program. It can also be used to stop the buzzer sound.

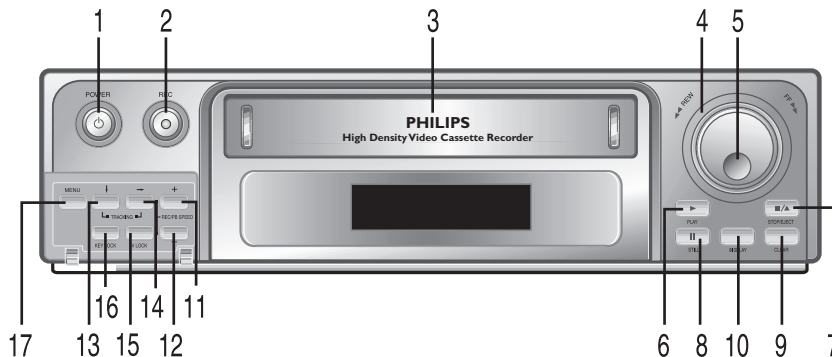

FIG. 1 - RT30A & RT960A FRONT

10. DISPLAY button - Pressing this button toggles between the CLOCK, COUNT and REMAIN displays. CLOCK shows the current time, COUNT shows the incremental counter for recording or playing, and REMAIN indicates the remaining time on the tape.
11. REC/PB SPEED UP- Selects the record/playback tape speed. UP button - Press to select from an ascending order, the record/ playback speed (6H, 18H, 30H...).
- Menu operation:* + button - Press to change the value of a setting on the menu screen.
12. REC/PB SPEED DOWN- Selects the record/playback tape speed. DOWN button - Press to select from a descending order, the record/playback speed (960H, 480H...).
- Menu operation:* - button - Press to change the value of a setting on the menu screen.
13. TRACKING (↓) - If noise appears on the screen during playback, press to adjust the tracking during the playback or slow mode.
- Menu operation:* ↓ button - Press to move the cursor down to the next available option on the menu screen.
14. TRACKING (→) - If noise appears on the screen during playback, press to adjust the tracking during the playback or slow mode.
- Menu operation:* → button - Press to move to the next menu screen.
15. V-LOCK button - If a picture is vertically vibrating during still mode or playback, press V-LOCK buttons until the vertical jitter on the Screen is reduced
16. KEY LOCK button - The KEY LOCK setting allows the user to prevent changes to the setting. The VCR stays in the current mode. Press again to unlock.
17. MENU button - Press to display and change the settings of the VCR while viewing on the video monitor.

3. SERIES indicator - Lights when you use two or more VCRs in series.
4. REC indicator - Lights when recording.
5. TIMER indicator - Lights when the timer recording mode is operating.
6. CASSETTE indicator - Lights when a cassette is loaded in the VCR.
7. INDEX indicator - Lights when scanning for playback detection of alarm events.
8. P.FAIL indicator - Lights when the VCR power had failed.
9. K.LOCK indicator - Lights when the key lock function is operational.
10. REPEAT indicator - Lights when repeat recording option is selected.
11. FUNCTION indicator - Displays the time, counter, remain indication.
12. VCR indicator - Displays the current VCR operational function as listed in the table below:

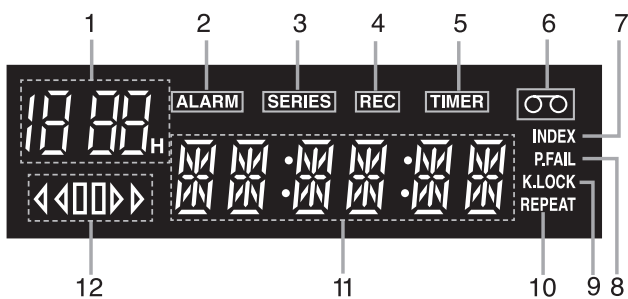

FIG. 2 DISPLAY WINDOW

Display Window:

1. VCR Speed indicator - Displays the selected VCR speed, A6, A18, A30, 72, 96 etc....(A = Audio)
2. ALARM indicator
ALARM appears during alarm recording.
ALARM flashes when alarm recording ends or acknowledged.

VCR Indication	
PLAYBACK	▶
REVERSE PLAYBACK	◀
STILL	▢▢
FAST FORWARD	▶▶
REWIND	◀◀
FORWARD SLOW/ FIELD ADVANCE	▢▶
REVERSE SLOW/ FIELD ADVANCE	◀▢
CUE	▶▶
REVIEW	◀◀
RECORDING	▶ REC
TIMER RECORDING	▶ REC TIMER
ALARM INDEX SEARCH	☀ INDEX
ALARM RECORDING	REC ALARM
SERIES RECORDING	REC SERIES
DOUBLE-SPEED PLAY	▶
REVERSE TRIPLE-SPEED PLAY .	◀

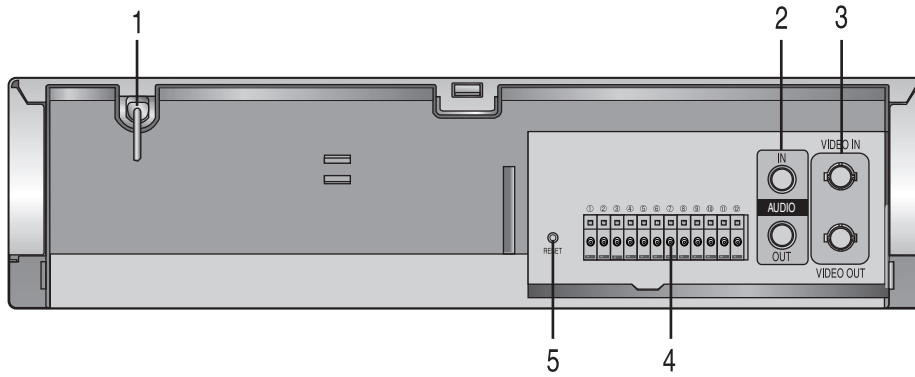

FIG. 3 - RT30A & RT960A REAR

Rear Connection Panel

1. POWER CORD - Connect to correct power supply.
2. AUDIO IN/OUT - Accepts an audio signal from a camera, external sound equipment or another recorder (Line: -6 dBm, 47 kOhm, unbalanced). Provides an audio output for a monitor or another VCR (-9 dBm, 1.5 kOhm, unbalanced).
3. VIDEO IN/OUT - IN - Receives video signal from a video camera or another VCR. OUT - For connection to monitor.
4. 12-PIN TERMINAL - Provides inputs/outputs for operational use:
 Pin 1 - Alarm IN
 Pin 3- Alarm OUT
 Pin 5 - Series IN
 Pin 6 - Series OUT
 Pin 8 - VEXT
 Pin 10 - Tape end OUT
 Pin 11 - 1-Shot record IN
 Pins 2, 4, 7, 9, 12 - GND
5. RESET - Press to reset the VCR.

TERMINAL	FUNCTION		SIGNAL LEVEL	IN/OUT
1.	ALARM IN		V^{IH} : 4-5V V^{IL} : 0--.6V, T : above 500 msec.	INPUT
3.	ALARM OUT		V^{OH} : 4-5V V^{OL} : 0--.6V, T : Alarm rec. state	OUTPUT
5.	SERIES IN		V^{IH} : 4-5V V^{IL} : 0--.6V, T : above 500 msec.	INPUT
6.	SERIES OUT		V^{OH} : 4-5V V^{OL} : 0--.6V, T : above 500 msec.	OUTPUT
8.	VEXT		V^{OH} : 4-5V V^{OL} : 0--.6V, T : above 500 msec.	OUTPUT
10.	TAPE END OUT		V^{OH} : 4-5V V^{OL} : 0--.6V, T : above 500 msec. end of tape or low tape or DECK error	OUTPUT
11.	1-SHOT REC IN		V^{IH} : 4-5V V^{IL} : 0--.6V, T : above 500 msec.	INPUT
2, 4, 7, 9, 12.	GND		OV	COMMON

5 INSTALLATION

Use coaxial cables when connecting a camera and a monitor to this VCR.

Note: Long cable runs to distant cameras may cause signal deterioration and/or sync discrepancies. If these problems occur, use video line amplifiers and/or cameras having phase-adjustable line-locked vertical sync.

5.1 Video Connection (Fig 4, Item 3)

Video Input - In single camera systems, connect the camera to the Video IN BNC terminal on the VCR rear panel. In multiple camera systems, connect the switcher/multiplexer output to the Video IN BNC terminal. Because multiple camera systems require synchronization, use of cameras having line-locked vertical sync or a genlocked master drive/sync source is highly recommended. The use of vertical interval switchers is also recommended.

Video Output - Connect the monitor to the Video OUT BNC terminal on the rear panel.

5.2 Audio Connection (Fig 4, Item 2)

Audio can be recorded at 6H, 18H, 30H speeds. To hear the playback sound, use the 6H, 18H or 30H speed during playback.

Audio In: Accepts an audio signal from a camera, external sound equipment, or another recorder (Line: -6 dBm, 47 kOhm).

Audio Out: Provides an audio output for a monitor or another recorder (-9 dBm, 1.5 kOhm, unbalanced).

5.3 Using the 12-pin Terminals (Fig 4, Item 4)

Attach the wires of the alarm switch, door sensor or warning lamp to the 12-pin terminal by pushing in the cable wire.

ALARM IN - You can connect an alarm input from a switcher/multiplexer to record an alarm event on tape. Connect input to pin 1 and ground to pin 9.

ALARM OUT - Approx. 5V is applied to pin 3 during an alarm recording. This can be used to trigger an external device (i.e. alarm bell).

SERIES - When two or more of this VCR model are used, connect via these terminals. See Series Record Connection for details. Connect Series IN to pin 5 and Series OUT to pin 6.

VEXT - Pin 8 outputs the following signal each time a one-field image is recorded. You can combine this with a video camera multiplexer which can be controlled externally.

TAPE END OUT - Approx. 5V is applied to pin 10 when the tape reaches the end.

1-SHOT REC IN - You can connect this input (pin 11) to ground (pin 12) to start a 1-shot recording.

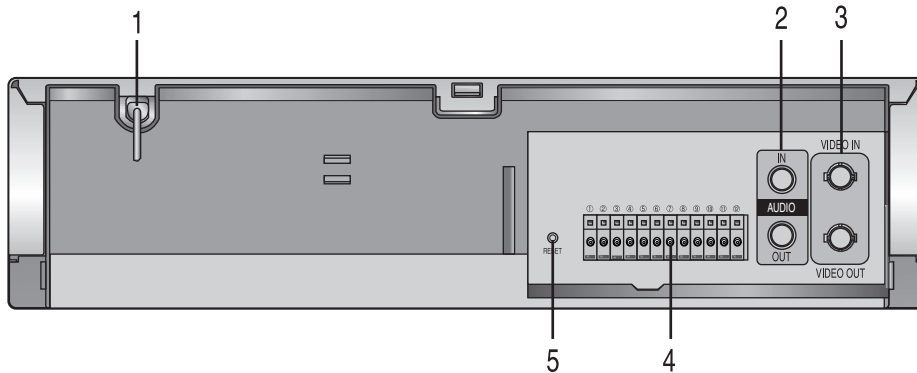

FIG. 4 - RT30A & RT960A CONNECTION

5.4 VCR Setup

Note: The cable of audio and video are not provided with your VCR.

How to connect a single camera:
Connect the VCR AUDIO/ VIDEO outputs to the MONITOR AUDIO/ VIDEO inputs.

Connect the CAMERA AUDIO/ VIDEO output to the VCR AUDIO/ VIDEO input.

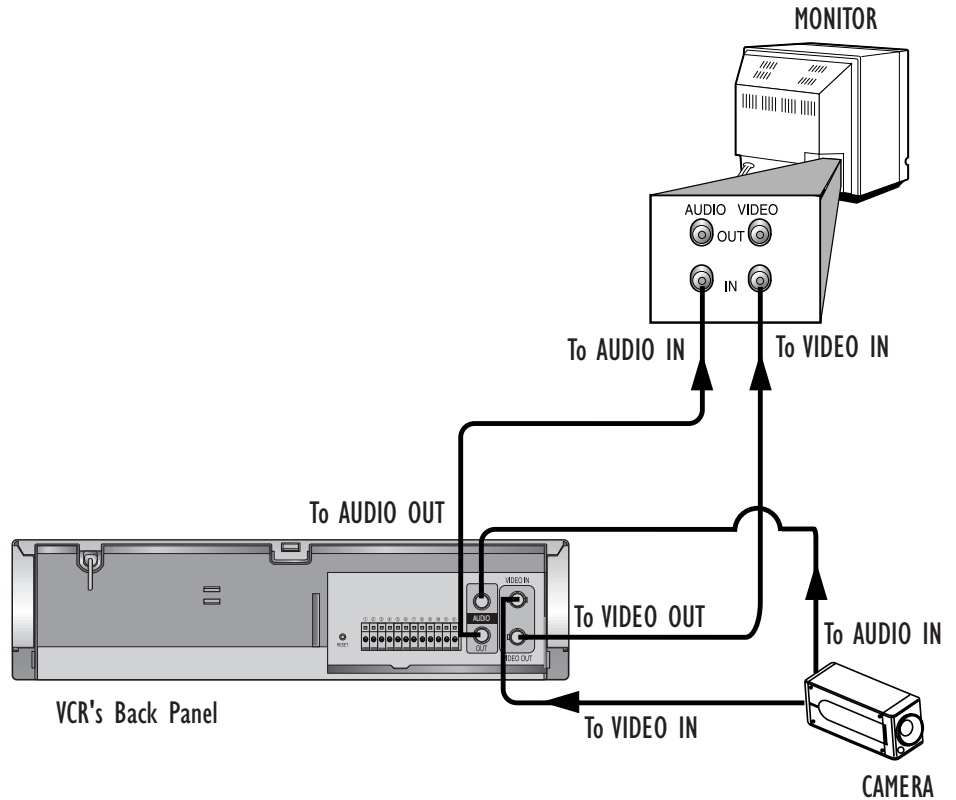

FIG. 5 - VCR CONNECTION TO SINGLE CAMERA (AUDIO & VIDEO)

How to connect a Multiplexer with VEXT Input Terminals:
Connect the VCR VIDEO output to the MULTIPLEXER PLAYBACK input.

Connect the VCR VIDEO input to the MULTIPLEXER REC output.

Connect the VCR VEXT pin 8 to the MULTIPLEXER VEXT terminal.

Connect the MULTIPLEXER GND terminals to the VCR GND pin 9.

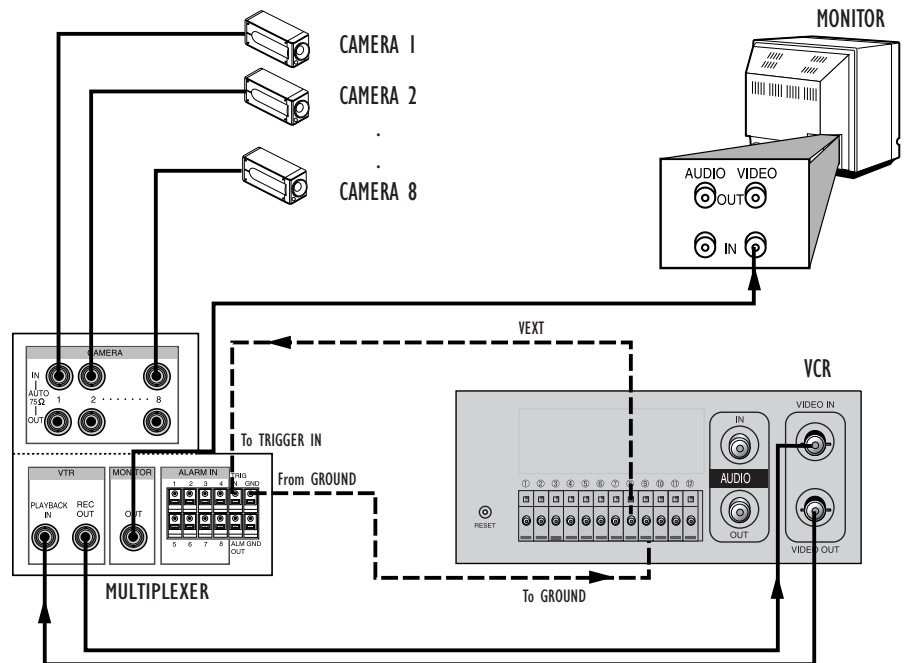

FIG. 6 - VCR CONNECTION TO MULTIPLEXER WITH TRIGGER FUNCTION

How to connect multiple cameras via switcher:

Connect the VCR VIDEO output to the MONITOR VIDEO input.

Connect the SWITCHER VIDEO output to the VCR VIDEO input.

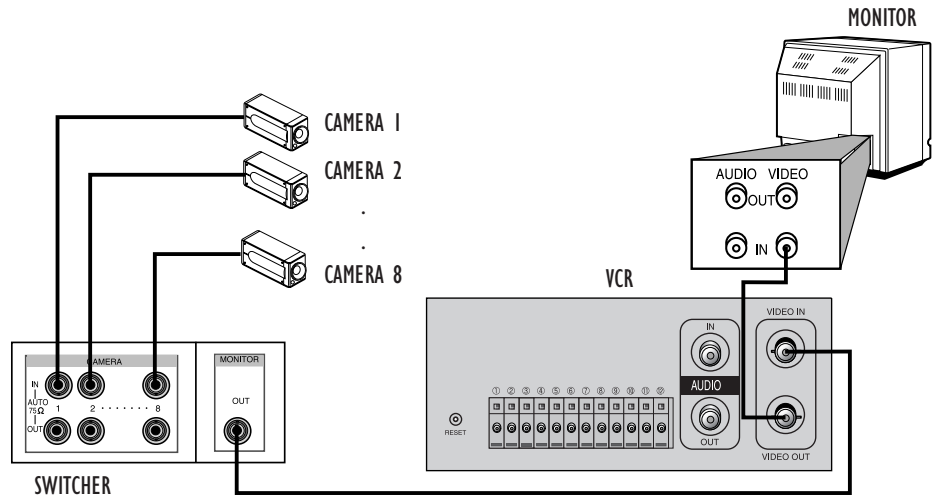

FIG. 7 - VCR CONNECTION TO SWITCHER

How to connect Alarms:

Connect the SWITCHER/MULTIPLEXER alarm output to the VCR alarm input, and then connect the SWITCHER/MULTIPLEXER GND to the VCR GND pin 4.

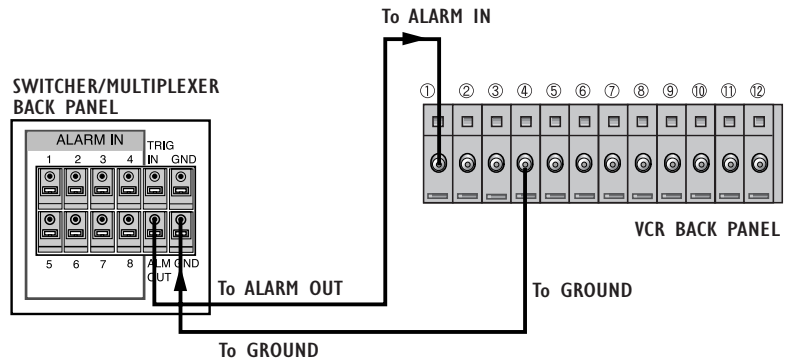

FIG. 8 - VCR ALARM CONNECTION

How to connect Series Record:

Connect the first VCR to CAMERA/SWITCHER. Connect the other VCRs in series.

After connecting, turn on the VCR, and then select the ON: SERIES mode in REC MODE menu.

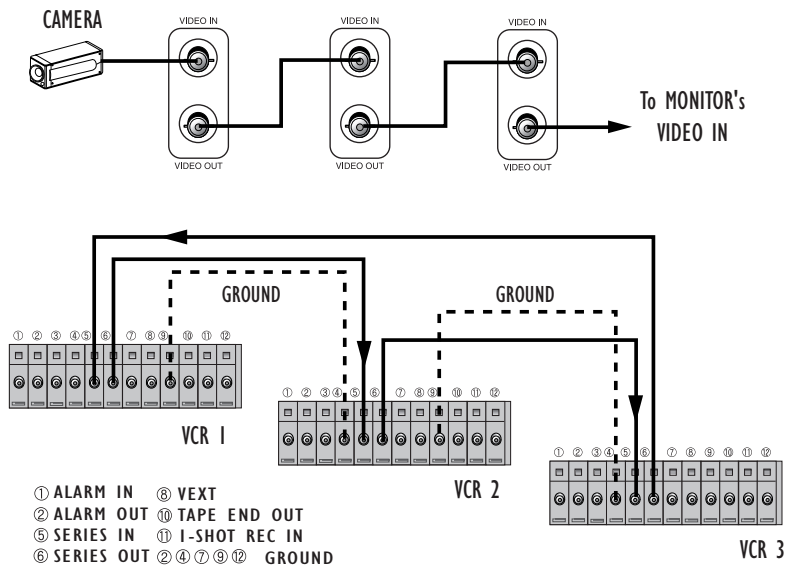

FIG. 9 - VCR SERIES RECORD CONNECTION

5.5 Video Cassette Tapes

This VCR will operate with any video cassette which has the **VHS** mark.

When handling video cassette tapes:

- Do not expose video cassettes to extreme heat, high humidity, or strong magnetic fields.
- Do not tamper with the cassette mechanism.
- Do not touch the tape with your fingers.
- Always store an unused cassette in its case.

LOADING

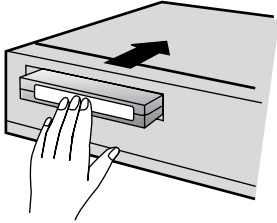

Loading:

Hold the cassette with the arrow side up (top). Insert the cassette gently into the slot in the direction of the arrow (on the cassette) until the loading mechanism automatically pulls the cassette into the unit. Make certain that the cassette is inserted correctly.

- If the cassette is not loaded correctly, the VCR will eject the cassette automatically after approximately 3 seconds.

UNLOADING

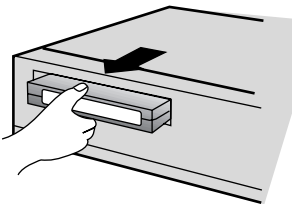

Unloading:

Press the STOP/EJECT button twice. The cassette will be ejected automatically. After the cassette is visible in the tape slot, pull it out to remove it.

- Unloading the cassette is possible only when the power cord is connected to the wall outlet.
- The cassette can be ejected when the STOP/EJECT button is pressed, even if the VCR's power is OFF.

SAFETY TAB

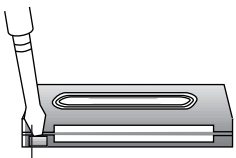

Video cassette safety tab:

To prevent accidental erasure of recorded material, remove the safety tab from the lower left corner of the cassette. Recording is impossible when the safety tab is removed.

5.6 Normal Playback

Turn on the power of both the VCR and the MONITOR.

1. Insert a prerecorded video cassette.

The  indicator will light and the VCR will power-up automatically.

If a tape without a record protect tab is inserted, the unit will start the playback automatically

2. Press the PLAY button.

Press - or + button to choose the desired time mode, 6H, 18H, 30H etc.

The selecting time is displayed in the VCR indicator panel.

If the tape reaches the end before STOP is pressed, the VCR will automatically stop and rewind.

3. Press the STOP button to stop playback.

Note:

- If during playback the STILL button is pressed, then after 5 minutes in this mode, the playback will automatically go into standby mode to protect the tape and video heads.

Tracking Control:

If noise appears on the screen during playback, press either ↓ or → buttons until the noise on the screen is reduced. In case of vertical jitter, adjust these controls very carefully. Tracking is automatically reset to normal when the tape is ejected.



V-Lock Control:

If a picture is vibrating vertically during still mode, 18, 30 or playback, press V-LOCK buttons until the vertical jitter on the screen is reduced.



Notes:

- A picture may have a slight vertical vibration, but this is normal.
- A distortion may appear on the top of the screen, but this is normal.
- If the recording speed and playback speed are different, the sound may not be play back normally.

5.6.1 Special Effects Playback

How to use the Shuttle Ring:

The shuttle ring is the outer dial. When the VCR is in the STOP mode, the shuttle ring can be rotated to the left or right then released, and the VCR will engage in the REWIND or FAST FORWARD function. While in the REWIND or FAST FORWARD mode, the shuttle ring can be rotated and held to engage the search mode. Releasing the shuttle ring returns it to the REWIND or FAST FORWARD function.

During Playback Mode:

When a picture is in the playback mode, the video can be viewed at variable speeds by rotating and holding the shuttle ring at different positions.

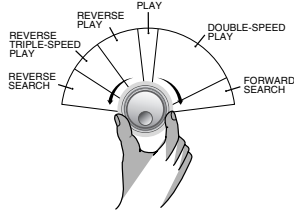

The figure illustrates the action that will occur at various positions.

The VCR returns to the playback mode upon release of the shuttle ring.

During Still Mode:

When a picture is in the still mode, the video can be viewed at variable speeds, including slow motion, by rotating and holding the shuttle ring at different positions.



The figure illustrates the action that will occur at various positions.

The VCR returns to the still mode upon release of the shuttle ring.

How to use the Jog Ring:

The jog ring is the center dial of the jog-shuttle ring. This ring is used to advance or reverse the video by single field when in the still mode.



To scan for alarm recordings, refer to paragraph 6.6.

5.6.2 Tape Counter Memory Feature

Real time Counter during PLAYBACK or RECORDING mode:

Press the DISPLAY button.



Whenever you press the DISPLAY button, the time, counter or remaining time is displayed alternately in the VCR indicator panel.

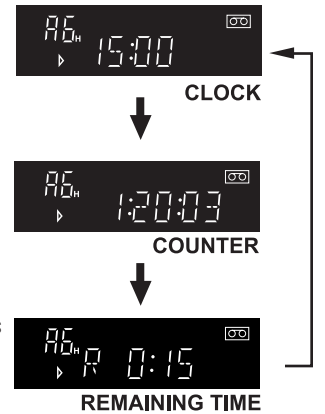

When the COUNTER is displayed:

- Counter changes to CLOCK when the cassette is ejected.
- The real-time counter does not operate when nothing is recorded on the tape.

Counter Memory Function:

This function is only provided when the COUNTER option is displayed in the VCR indicator panel.

1. Begin recording or playing a tape.



Continue to play or record.

2. At the point where you want the playback to begin, reset the real-time counter to 0:00:00 by pressing the CLEAR button.



3. Press the STOP button when recording or playback finishes.



4. Rotate and release the SHUTTLE ring to reverse.

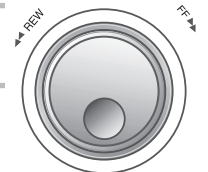

The VCR will stop at the COUNTER position 0:00:00.

Tape Remaining:

This function allows the time of the remaining tape to be displayed during recording or playback.

1. Press the DISPLAY button until the remaining time displays on the TV screen.
2. Start recording or playback.



Note: The remaining time is not displayed during 72H, 96H,000H recording or playback mode.

5.7 Normal Recording

Turn on the power of both the VCR and the MONITOR.

1. Insert the VIDEO CASSETTE. Ensure the safety tab is in place.

2. Press – or + to choose the desired recording speed, 6H, 18H, 30H etc.



The selected time is displayed in the VCR indicator panel, A6H > A18H > A30H > 72H > 96H > 120H > 160H > 240H > 480H > 960H > 000H.

Notes:

- If you select the '000H' option in normal recording, the VCR will activate the '1SHOT REC' mode function. This will record a single shot picture after each defined time interval which is programmed in the '1SHOT REC' menu (see 6.2 Record Mode Set Up menu). You can select the '1SHOT REC' time interval for 1 sec., 3 sec., 5 sec., 15 sec., 30 sec., 60 sec., or OFF.
- If you select '1SHOT REC' OFF, the unit will record one picture each time the external 1SHOT REC input is activated.

3. Press the REC button.

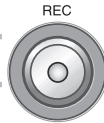

Recording will start. (The REC indicator will light in VCR indicator panel.)

4. Press the STOP button to stop recording.



To PAUSE the recording during the RECORDING mode:

1. Press the STILL button to pause the tape.



2. When you want to continue recording, press the STILL button again.



After 5 minutes in STILL mode, the recording will automatically go into the standby mode to protect the tape and the video heads.

To Record Check during the RECORDING mode:

When in record mode, pressing the PLAY should cause the unit to reproduce recently recorded video.

3. Press PLAY to reproduce recently recorded video. (Playback of the last 4 seconds of recorded video will be displayed).



After the Record Check, the unit return to the original recording mode.

6 SETTING THE ON-SCREEN DISPLAY

The MAIN MENU displays a list of options that you can use to setup the VCR.

1. Turn on the power of both the VCR and the MONITOR.

2. Press MENU button and the main menu will appear.



3. Select the desired menu with the ↓ button and then press the → button to enter the respective menu table.

4. To exit a menu press the MENU button. To exit the menu option completely, press the MENU button repeatedly until you have exited all the menus, and returned to normal use.



LANGUAGE:

This allows you to view the menus in your selected language.

1. Press the ↓ button to select the LANGUAGE option and then press the → button to toggle between English, French, Spanish, German, Italian, Dutch and Portuguese.

OTHER MENUS:

You can setup the VCR to your specific requirements using the menus listed. The functionality of each menu is described in the following paragraphs.

2. Press the ↓ button to select the respective menu option that you want to setup and then press the → button to enter the menu.

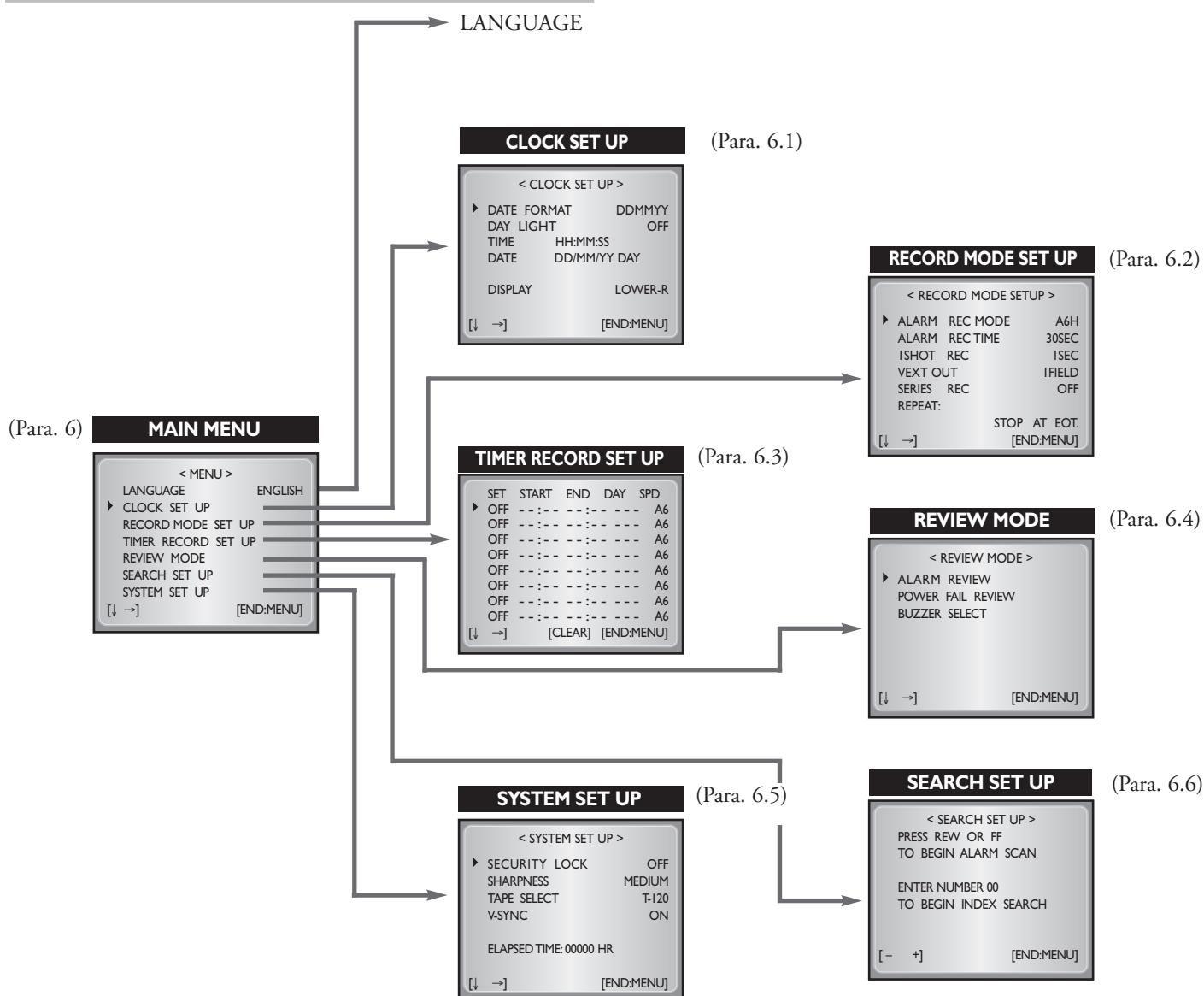

FIG. 9 - MENU NAVIGATION

6.1 CLOCK SET UP Menu

The CLOCK SET UP MENU enables you to define the date and time options and how they are displayed on the monitor screen. The clock uses the 24-hour system.

1. Press the MENU button.



The main menu will appear:

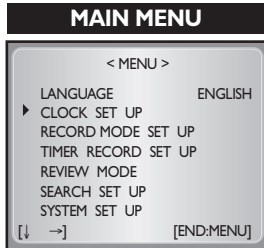

2. Press the ↓ button to select the CLOCK SET UP option and then press the → button to enter the menu.

The CLOCK SET UP menu will appear:

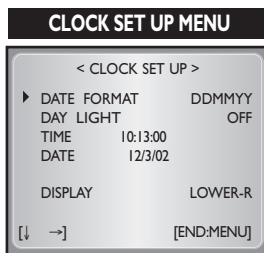

DATE FORMAT - Display format can be changed to DDMMYY, MMDDYY and YYMMDD.

3. Press the ↓ button to select the DATE FORMAT option and then press the → button to change the format.

DAY LIGHT SAVING - The time moves forward 1 hour when you select ON.

4. Press the ↓ button to select the DAY LIGHT option and select ON/OFF by pressing the → button.

TIME - Set the current time.

5. Press the ↓ button to select the TIME option and then press the → button the select the hour/minute/second digit. Press the – or + to change the selected time digit.

DATE - Set the current time.

6. Press the ↓ button to select the DATE option and then press the → button the select the day/month/year digit. Press the – or + to change the selected date digit.

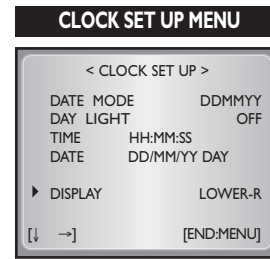

DISPLAY - Select the time/date display position on the screen display (LOWER-R, LOWER-L, UPPER-L, UPPER-R, OFF).

7. Press the ↓ button the select the DISPLAY option and then press the → button to change to the required selection.

8. Press MENU button when finished.

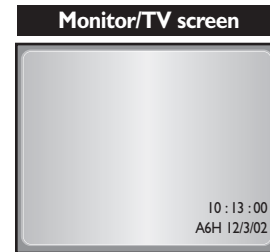

6.2 RECORD MODE SET UP Menu

The RECORD MODE SET UP MENU enables you to define the VCR alarm options. Alarm recording will start when an external alarm signal (an alarm event) is input to the VCR. This function operates when the VCR is connected to a switcher or multiplexer with an alarm output terminal.

Notes:

- Before the alarm recording, refer to the alarm record connection diagram.

1. Press the MENU button and the main menu will appear.

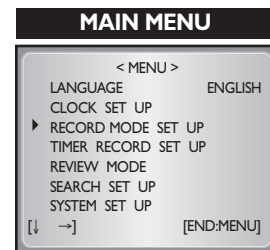

2. Press the ↓ button to select the RECORD MODE SET UP option and then press the → button to enter the menu.

The RECORD MODE SET UP menu will appear.

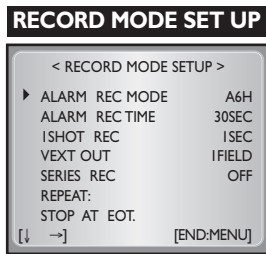

ALARM REC MODE - This defines the alarm recording mode option. When an alarm occurs, the VCR will record the alarm at the selected tape speed 6H, 18H or 30H, and then revert back to the real-time recording speed.

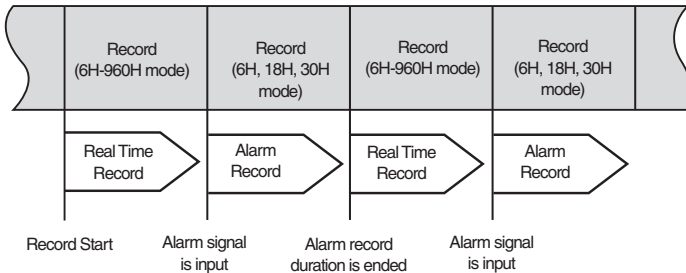

3. Press the ↓ button to choose the ALARM REC MODE option.

4. Press the → button to select alarm recording hours.

ALARM REC TIME - This defines the amount of time that the alarm is recorded, 30 sec., 1 min., 3 min., 5 min., 10 min. or T.END.

5. Press the ↓ button to choose the ALARM REC TIME option.

6. Press the → button to select the desired time of recording, 30 sec., 1 min., 3 min., 5 min., 10 min. or T.END (Tape end).

- If you choose the T.END, alarm recording is continued until tape end is reached.
- While the alarm is in process, the buzzer will ring. If you want to stop buzzer, press CLEAR button.
- The ALARM indicator in VCR indicator panel will appear when the alarm recording is proceeding.

1SHOT REC - This defines the interval time that one picture is recorded, 1 sec., 3 sec., 5 sec., 15 sec., 30 sec., 60 sec. or OFF.

Notes:

- If you select the '000H' option in normal recording, the VCR will activate the '1SHOT REC' mode function. This will record a single shot picture after each defined time interval which is programmed in the '1SHOT REC' menu.

- If you select '1SHOT REC' OFF, the unit will record one picture each time the external 1SHOT REC input is activated.

7. Press the ↓ button to choose the 1SHOT REC option.

8. Press the → button to select the desired time of recording, 1 sec., 3 sec., 5 sec., 15 sec., 30 sec., 60 sec. or OFF.

VEXT: In case of connecting the external equipment (switcher or multiplexer), you can set the switching time of the camera.

9. Press the ↓ button to select the VEXT option and then press the → button to select either 1 Field, 2 Field, 5 Field, 10 Field, 30 Field, or 60 Field (these are the number of fields recorded after one VEXT pulse).

Note:

- Your update rate will be decreased with the same factor as the number of fields selected.

SERIES REC - The Series Recording mode is convenient, when you record with two or more VCRs. If you have two VCRs in the Series Recording mode, the second VCR will start to record automatically at the end of the first VCR recording.

Notes:

- Before Series Recording, refer to the connection diagram on how to connect Series Record VCRs.
- Make sure a tape is in the each VCR and the safety tab is in place.
- The SERIES recording is not available when the Timer recording is in stand-by mode.
- The SERIES and REPEAT options on the REC MODE menu are not be set to the ON mode simultaneously.

10. Press the ↓ button to choose the SERIES REC option and press the → button to choose ON/OFF for each VCR.

REPEAT - This function is used to select how the recording tape is used before starting a recording. These are:

- **STOP AT EOT:** Tape stops when it reaches end of tape in RECORD mode.
- **RE-REC EVEN IF ALARM:** Rewinds tape and enters RECORD mode at beginning of tape even if there has been alarm.
- **REWIND, STOP:** Rewinds tape and then enters STOP mode.
- **STOP IF ALARM:** Rewinds tape and enters RECORD mode at beginning of tape, if there has been an alarm recording it enters the STOP mode at end of tape.

11. Press the ↓ button to choose the REPEAT option and press the → button to choose the available options (see list above).

6.3 TIMER RECORD SET UP Menu

This VCR can be programmed to record up to 8 different programs. The TIMER RECORD SET UP option can be programmed ON or OFF, the start/end times, the day of the week and the recording speed can be set. Options are:

SET - ON/OFF. Allows you to define the timer recording and select the option on or off.

START - Sets the start time of recording.

END - Sets the stop time of recording.

DAY - Sets the day of the timer recording. Options are:

SUN ~ SAT: Same time once a week.

M-F or S-S: Same time during Monday ~ Friday or Saturday ~ Sunday

DLY: Same time(s) for every day

SPD - Sets the recording time mode. Options are: 6H, 18H, 30H, etc.

1. Press the MENU button and the main menu will appear.

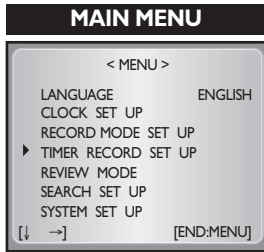

2. Press the ↓ button to choose the TIMER RECORD SET UP option and press the → button to enter the menu.

The TIMER RECORD SET UP menu will appear. You can now setup the timer recording.

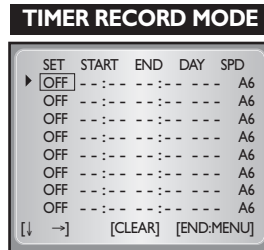

3. Press the ↓ button to move the first available SET option (or the SET option you want to change).
4. Press the → button and the SET item will flash. Press the + or - button to choose ON or OFF.
5. Press the → button to move next item (day, start time, end time recording hour) and repeat the process by using the +, - and → buttons.

Note: If you are finished programming and you want to set the VCR to record the programs you have entered.

- **MAKE SURE YOU HAVE INSERTED A TAPE INTO THE VCR.**
- **THE POWER BUTTON MUST BE SWITCHED TO OFF BEFORE THE VCR WILL RECORD ANY TIMER PROGRAMS. (TIMER appears).**

The VCR is now set to record the preset programs.

6.4 REVIEW MODE Menu

The REVIEW MODE enables you to display on the monitor screen the alarm events, power failures, and to set the buzzer options. You can also clear any alarms or power failure events.

1. Press the MENU button and the main menu will appear.

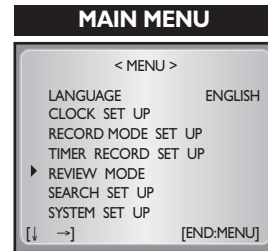

2. Press the ↓ button to select the REVIEW MODE option and then press the → button to enter the menu.

The REVIEW MODE menu will appear.

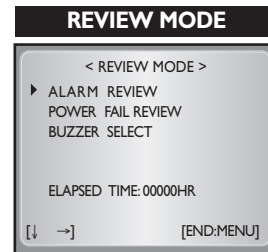

ALARM REVIEW: Allows you to view alarm events and then clear the alarm.

3. Press the ↓ button to choose the ALARM REVIEW option and then press the → button.

ALARM REVIEW menu will appear.

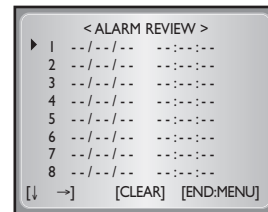

The list will show alarm events. Alarm record information can be memorized up to 16, but only 8 can be displayed on the MONITOR.

4. Press the -/+ button to view the next/previous page.

5. Press the ↓ button to choose the respective alarm.

6. To erase the alarm record information press the CLEAR button. On the display panel, the "ALARM" indication will also be cancelled.



POWER FAIL REVIEW - You can review or clear the POWER FAIL REVIEW while your are recording.

7. Press the ↓ button to select the POWER FAIL REVIEW option and then press the → button.

The POWER FAIL REVIEW menu will appear.

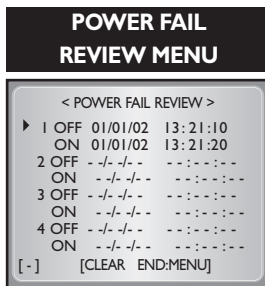

■ Up to 8 Power fail information lines can be viewed.

8. To erase the power fail review select the respective power fail review item and then press the CLEAR button. The power fail review is erased. On the display panel the "P.FAIL" indication will also be cancelled.



BUZZER SELECT - Allows you to set up the buzzer option. You can select:

- VIDEO LOSS : When the video signal fails, the buzzer will operate.
- ERROR MODE : When the VCR operates incorrectly, the buzzer will operate.
- TAPE END : When the VCR reaches the end of tape, the buzzer will operate.
- NO TAPE : When the tape is not inserted when you press the PLAY, FF, REW, REC, STOP, EJECT button, the buzzer will operate.
- NO SAFETY TAB : When the safety tab is absent when you press REC or the TIMER is programmed, the buzzer will operate.

9. Press the ↓ button to select the BUZZER SELECT option and then press the → button to enter the menu.

BUZZER SELECT menu will appear.

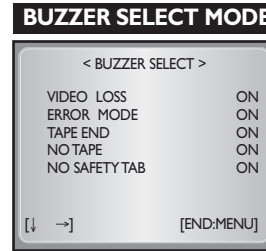

10. Press the ↓ to choose the respective option and then press the → button to select ON/OFF.

Note:

- The TAPE END buzzer selection is only activated when you have selected "RE-REC EVEN IF ALARM" or "STOP IF ALARM (when there is no alarm)" in the REPEAT function.

6.5 SYSTEM SET UP Menu

The SYSTEM SET UP allows you to personalise your system by defining access control and system specification settings.

1. Press the MENU button. The main menu will appear.

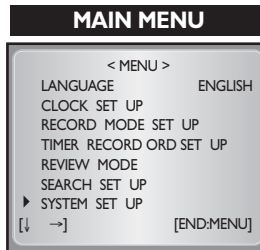

2. Press the ↓ button to select SYSTEM SET UP and press the → button to enter the menu.

The SYSTEM SET UP menu will appear.

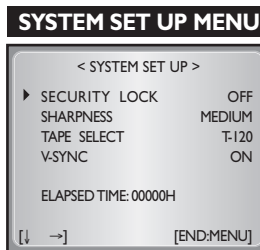

SECURITY LOCK - The security lock ensures that the VCR tape cannot be removed. Note:

- If the SECURITY LOCK is "ON", the tape will eject only if the eject button is pressed for more than 5 seconds.
- If the auto eject mode is operational, the tape will just stop when ended.

- Press the ↓ button to select SECURITY LOCK and press the → button to select ON/OFF.

SHARPNESS - The sharpness of the recorded picture can be selected between LOW, MEDIUM or HIGH.

- Press the ↓ button to select SHARPNESS and press the → button to set LOW, MEDIUM or HIGH.

TAPE SELECT - Allows you to define the type of tape in use (T-120, T-160, T-180, T-210 or E-180, E-240, E-260, E-300). This is requested to ensure the VCR can calculate the "Tape Remaining" time.

- Press the ↓ button to select TAPE SELECT and press the → button to scroll through the options.

V-SYNC - To obtain the best picture quality when in playback mode, adjust the picture by V-LOCK to ON/OFF, and adjust the tracking. The V-SYNC is switched between ON and OFF during playback by pressing the V-LOCK button.

- Press the ↓ button to select V-SYNC and press the → button to set ON/OFF.

ELAPSED TIME - This displays the total amount of time of recording and playback. The ELAPSED TIME is a check of the used time of the video head.

6.6 SEARCH SET UP Menu

The SEARCH SET UP function enables you to search for specified alarm events. By entering the menu, and entering the alarm number (found in the ALARM REVIEW MODE menu), the VCR will automatically search the tape for the alarm index.

To scan alarm recordings during the STOP mode when the tape is inserted:

- Press the MENU button and the main menu will appear.

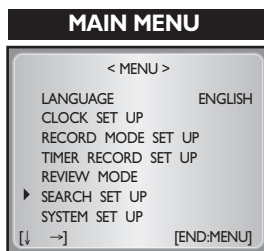

- Press the ↓ button to select the SEARCH SET UP menu, and press the → button to enter the menu.

SEARCH SET UP MENU

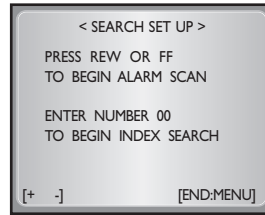

- Rotate and release the SHUTTLE ring to FF or REW.

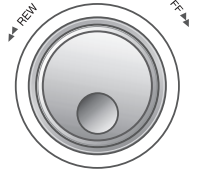

The INDEX indicator will flash in the VCR indicator panel. The detected alarm recording will play for 5 seconds and then the search mode will continue to the next alarm recording.





- Selecting SEARCH SET UP brings up an Alarm Search Screen. Use the – or + buttons to select the number of alarm to search, then use the shuttle ring to advance or rewind the tape to the number of selected search positions.

7. SELF-DIAGNOSIS

This function informs you of error messages to help you solve system problems.

When the VCR malfunctions, the error code is displayed in the VCR indicator panel.

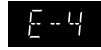

ERROR CODE TABLE

DISPLAY	DESCRIPTION	ACTION
	Loading Motor Error	<ul style="list-style-type: none"> • When a malfunction occurs in the VCR, press the POWER button on the front of VCR to operate normally. • If an error message (Err) appears on the display continuously when the any button is pressed, contact your dealer or service center.
	Tape Loading Error	
	Tape Eject Error	
	Reel Rotational Error	
	Drum Motor Error	

ON-SCREEN MESSAGE

DISPLAY	CHECK POINT
“NO TAPE”	• Check if a Tape is inserted.
“NO SAFETY TAB”	• Check if a cassette has a safety tab.
“VIDEO LOSS”	• Check if the video cable is correctly connected to VIDEO IN or problems with the video source.

8. TROUBLESHOOTING

SYMPTOM	CHECK POINT & CORRECTION
Cassette cannot be inserted.	<ul style="list-style-type: none"> • Load cassette in direction indicated by arrow on cassette. • A cassette is already in the VCR. • Check if power indicator is lit on the VCR indicator panel. If not, make sure power cord is plugged in. • If the  indicator flashes, press the POWER button again.
The VCR will not go into the recording mode, even when REC button is pressed.	<ul style="list-style-type: none"> • The cassette has had the erase prevention tab removed. Stick a piece of cellophane tape over the erase prevention tab hole or select a different cassette.
No picture appears on monitor screen when PLAY button is pressed.	<ul style="list-style-type: none"> • Try a different cassette tape. • Check if the system is connected right.
No picture, but audio is clear.	<ul style="list-style-type: none"> • The heads may require cleaning. • Take VCR to a qualified Service Center for service.
Interference on playback picture.	<ul style="list-style-type: none"> • Adjust fine tuning knob on monitor set to obtain best picture. • Adjust TRACKING control button. • Take VCR to Service Center for service.
VCR does not start at preset record starting time.	<ul style="list-style-type: none"> • Is power button switched to off. • Setup recording time according to instructions.
The tape is ejected in the timer or alarm recording mode.	<ul style="list-style-type: none"> • The cassette has had the erase prevention tab removed. Stick a piece of cellophane tape over the erase prevention tab hole or select a different cassette.
 indication flashes.	<ul style="list-style-type: none"> • Insert a cassette.

Using the RESET button (located at the rear panel of VCR)

This button should be used to solve the following symptoms;

- When the power can not on, even if power cord is connected to the outlet.
- When the VCR's display does not display.
- When the VCR does not operate normally.

- Use a pencil or ball-pen when you press the RESET button.

Warning: System will go to default settings.

9. MAINTENANCE GUIDE TABLE

The table below shows the recommended service intervals for the VCR components.

Unit is Hour.

NO.	DESCRIPTION	1000	2000	3000	4000	5000	6000	7000	8000	9000	10000
1	DRUM ASSY	*	*	*	#	*	*	*	#	*	*
2	MOTOR CAPSTAN	*	*	*	*	*	*	*	#	*	*
3	BELT CAPSTAN				#				#		
4	BASE ASSY A/C	*	*	*	*	*	*	*	*	*	#
5	HEAD F/E	*	*	*	*	*	*	*	*	*	#
6	ARM ASSY IDLER										#
7	ARM ASSY F/L										#
8	CAPSTAN SOFT BRAKE				#				#		
9	CLUTCHAY				#				#		
10	PINCH ROLLER ASSY				#				#		

Reference:
 Changing #: Cleaning *

Notes:
 • Check the running path adjustment when you change the 1, 3, 5, 6 item.

MOISTURE CONDENSATION:

If you pour a cold liquid into a glass, water vapor in the air will condense on the surface of the glass. This is moisture condensation. Moisture condensation on the head drum, one of the most crucial parts of the unit, will cause damage to the tape.

When the VCR is exposed to a rapid temperature change from cold to warm, some condensation will occur. Under this condition, connect the power cord to the AC line, press the POWER button ON and allow at least two hours for the VCR to dry out.

10. SPECIFICATIONS

Electrical

Model No.	Rated Voltage	Voltage Range	Power at Min. Voltage
RT30A/50	230 Vac, 50 Hz	90 to 264	22 W
RT960A/50	230 Vac, 50 Hz	90 to 264	22 W
RT30A/60	120 Vac, 60 Hz	90 to 264	22 W
RT960A/60	120 Vac, 60 Hz	90 to 264	22 W

Tape Format: Standard 12.7 mm (0.5 inch) VHS tape.

Video Recording System: VHS

Rotary Heads: Four head helical scan azimuth system.

Luminance: FM recording.

Color: Converted subcarrier, direct recording.

Selectable Speeds (Recording & playback):

RT30A/50: 6, 18, and 30 hours on E-180 tape.

RT960A/50: 6, 18, 30, 72, 96, 120, 168, 240, 480, and 960 hours on E-180 tape.

RT30A/60: 6, 18, and 30 hours on T-120 tape.

RT960A/60: 6, 18, 30, 72, 96, 120, 168, 240, 480, and 960 hours on T-120 tape.

Time-Lapse recordings are reviewed in 3 hours for -/50 models and 2 hours for -/60 models.

Alarm Record Speeds:

RT30A/50 & RT960A/50: 6, 18, and 30 hours mode.

RT30A/60 & RT960A/60: 6, 18, and 30 hours mode.

High Speed Video Scan:

RT30A/50 & RT960A/50: 9 x 6-hour speed.

RT30A/60 & RT960A/60: 9 x 6-hour speed.

Rewind/Fast Forward Time: Less than 70 seconds (E-180 or T-120 tape).

Alarm Command:

From the Recording or Ready Mode:

Turns on Alarm Indicator and "Alarm-On" output.

Inserts Alarm-Code in on-screen display for easy location during later visual search.

The selected alarm recording speed can be programmed to continue for a period of 30 seconds, 1, 3, 5, 10 minutes or until tape end.

Typical Delay Time Before Alarm Recording:

From STOP Mode: Approx. 3 sec.

From RECORD Mode: Less than 1 sec.

Video:

RT30A/50 & RT960A/50: PAL color/ CCIR monochrome.

RT30A/60 & RT960A/60: NTSC color/EIA monochrome.

Input: 1.0 V_{p-p}, 75 ohm, unbalanced.

Output: 1.0 V_{p-p}, 75 ohm, unbalanced.

Horizontal Resolution:

Monochrome: 320 TV lines.

Color: 270 TV lines.

Signal-to-Noise: more than 43 dB (6-hour mode).

Audio:

Audio Recording possible in 6, 18, 30 hours mode

Input: -6.0 dBm, 47 kohm, unbalanced.

Output: -9.0 dBm, 1.5 kohm unbalanced.

Frequency Range 100 Hz to 5 kHz. (6-hour mode)

Signal-to-Noise: more than 43 dB (6-hour mode)

Time/Memory Power-Loss Backup: 2 weeks

Indicators:

Real-time VCR speed

Alarm

Series

Record

Timer

Cassette

Index

Power failure

Key lock

Repeat

Function (clock, tapcounter, error)

VCR function

Controls:

Power

Record

Joggle Shuttle

Play

Stop/Eject

Still

Clear

Clock

Menu

Key lock

Tracking

V-lock

Connectors:

VIDEO IN: 1; BNC.

VIDEO OUT: 1; BNC.

AUDIO IN: RCA Phono jack.

AUDIO OUT: RCA Phono jack.

EXTERNAL INTERFACE*: 12-pin terminal strip adapter.

* Alarm In/Out; Series In/Out; VEXT; Tape End Out; I-Shot Record In.

Mechanical

Finish: Gray

Dimensions (w x d x h) : 360 x 270 x 94 mm (14.2" x 10.6" x 3.7")

Weight: Approximately 3.8 kg (8.4lbs)

Environmental

Temperature: +5 °C to +40 °C (+41 °F to +105 °F).

Humidity: Less than 80% RH

Electromagnetic Compatibility

EMC Requirements:

50 Hz Models: 89/336/EEC.

Immunity: EN50130-4.

Emission: EN55022 Class B.

Harmonics: EN61000-3-2.

Voltage Fluctuations: EN61000-3-3.

60 Hz Models: U.S.A. and Canada.

FCC Part 15, Class B.

Safety:

50 Hz Models: CE.

LVD Requirements: 73/23/EEC; EN60065.

60 Hz Models: UL & cUL.

UL: UL 1492.

CSA: CSA 22.2, No.1.

Recording Times: PAL models (-/50)

Record Mode		Actual hrs		Tape Speed	Recording Fields	Drive	Audio
RT30A	RT960A	E-180	E-240				
6H	6H	6H	8H	11.69mm/sec	50fields/sec	Continuous	Yes
18H	18H	18H	24H	3.90mm/sec	16.67fields/sec	Continuous	Yes
30H	30H	30H	40H	2.34mm/sec	10fields/sec	Continuous	Yes
	72H	78H	104H	0.90mm/sec	3.85fields/sec	Intermittent	No
	96H	102H	135H	0.69mm/sec	2.95fields/sec	Intermittent	No
	120H	126H	168H	0.56mm/sec	2.38fields/sec	Intermittent	No
	168H	174H	232H	0.40mm/sec	1.73fields/sec	Intermittent	No
	240H	246H	328H	0.29mm/sec	1.22fields/sec	Intermittent	No
	480H	486H	648H	0.14mm/sec	0.62fields/sec	Intermittent	No
	960H	966H	1288H	0.07mm/sec	0.31fields/sec	Intermittent	No

Recording Times: NTSC models (-/60)

Record Mode		Actual hrs		Tape Speed	Recording Fields	Drive	Audio
RT30A	RT960A	T-120	T-160				
6H	6H	6H	8H	11.12mm/sec	60fields/sec	Continuous	Yes
18H	18H	18H	24H	3.71mm/sec	20fields/sec	Continuous	Yes
30H	30H	30H	40H	2.22mm/sec	12fields/sec	Continuous	Yes
	72H	78H	104H	0.93mm/sec	5fields/sec	Intermittent	No
	96H	102H	135H	0.70mm/sec	3.75fields/sec	Intermittent	No
	120H	126H	168H	0.56mm/sec	3fields/sec	Intermittent	No
	168H	174H	232H	0.40mm/sec	2.14fields/sec	Intermittent	No
	240H	246H	328H	0.28mm/sec	1.5fields/sec	Intermittent	No
	480H	486H	648H	0.14mm/sec	0.75fields/sec	Intermittent	No
	960H	966H	1288H	0.07mm/sec	0.38fields/sec	Intermittent	No

